

**Product Summary**

$V_{RRM}$	650 V
$I_F (T_C=150^\circ\text{C})$	4 A
$Q_C$	14 nC

**Features**

- Extremely low reverse current
- No reverse recovery current
- Temperature independent switching
- Positive temperature coefficient on  $V_F$
- Excellent surge current capability
- Low capacitive charge

**Benefits**

- Essentially no switching losses
- System efficiency improvement over Si diodes
- Increased power density
- Enabling higher switching frequency
- Reduction of heat sink requirements
- System cost savings due to smaller magnetics
- Reduced EMI

**Applications**

- Switch mode power supplies (SMPS)
- Uninterruptible power supplies
- Motor drivers
- Power factor correction

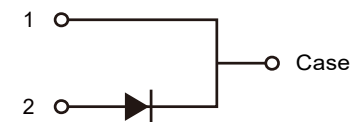
**Package Pin Definitions**

- Pin1 and backside - Cathode
- Pin2 - Anode

**Package Parameters**

Part Number	Marking	Package
B2D04065K1	B2D04065K1	TO-220-2

**Package: TO-220-2**

**Electrical Connection**


**Maximum Ratings ( $T_c=25^\circ\text{C}$  unless otherwise specified)**

Symbol	Parameter	Test conditions	Value	Unit
$V_{RRM}$	Repetitive peak reverse voltage		650	V
$V_{RSM}$	Non-repetitive peak reverse voltage		650	V
$I_F$	Continuous forward current	$T_c=25^\circ\text{C}$ $T_c=150^\circ\text{C}$	18 4	A
$I_{FSM}$	Non-repetitive forward surge current	$T_c=25^\circ\text{C}$ , $t_p=10\text{ms}$ Half sine wave	34	A
$\int i^2 dt$	$i^2t$ value	$T_c=25^\circ\text{C}$ , $t_p=10\text{ms}$	5	A <sup>2</sup> S
$P_{tot}$	Power dissipation	$T_c=25^\circ\text{C}$ $T_c=110^\circ\text{C}$	91 39	W
$T_j$	Operating junction temperature		-55~175	$^\circ\text{C}$
$T_{stg}$	Storage temperature		-55~175	$^\circ\text{C}$
	TO-220 mounting torque	M3 Screw	0.7	Nm

**Thermal Characteristics**

Symbol	Parameter	Value			Unit
		Min.	Typ.	Max.	
$R_{th(jc)}$	Thermal resistance from junction to case		1.643		K/W

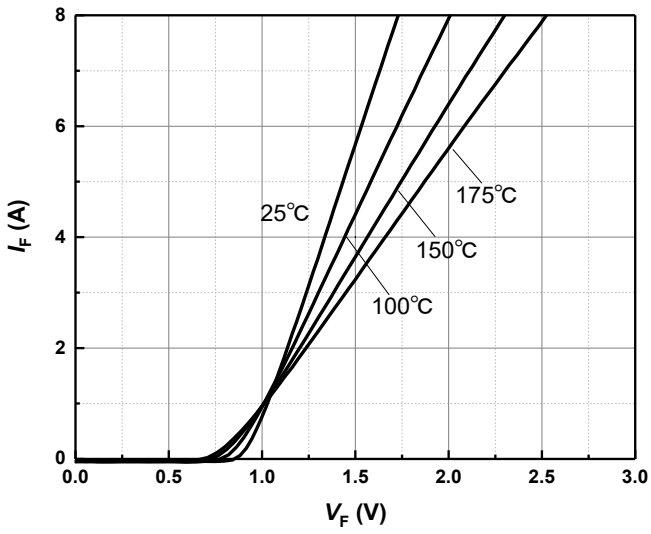
**Electrical Characteristics**  
**Static Characteristics**

Symbol	Parameter	Test conditions	Value			Unit
			Min.	Typ.	Max.	
$V_{DC}$	DC blocking voltage	$T_j=25^\circ\text{C}$	650			V
$V_F$	Diode forward voltage	$I_F=4\text{A } T_j=25^\circ\text{C}$ $I_F=4\text{A } T_j=175^\circ\text{C}$		1.33 1.6	1.5 2.1	V
$I_R$	Reverse current	$V_R=650\text{V } T_j=25^\circ\text{C}$ $V_R=650\text{V } T_j=175^\circ\text{C}$		1 20	70 200	$\mu\text{A}$

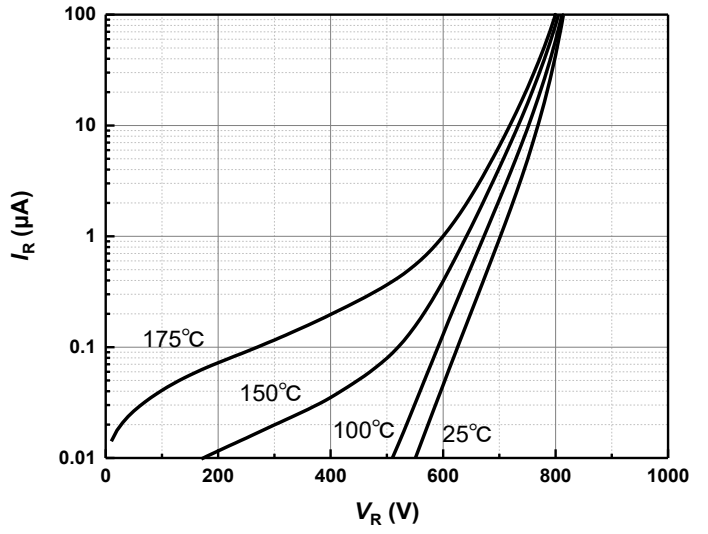
**AC Characteristics**

Symbol	Parameter	Test conditions	Value			Unit
			Min.	Typ.	Max.	
$Q_C$	Total capacitive charge	$V_R=400\text{V } T_j=25^\circ\text{C}$ $Q_C=\int_0^{V_R} C(V)dV$		14		nC
$C$	Total capacitance	$V_R=1\text{V } f=1\text{MHz}$ $V_R=300\text{V } f=1\text{MHz}$ $V_R=600\text{V } f=1\text{MHz}$		183 26 25		pF
$E_C$	Capacitance stored energy	$V_R=400\text{V}$		3		$\mu\text{J}$

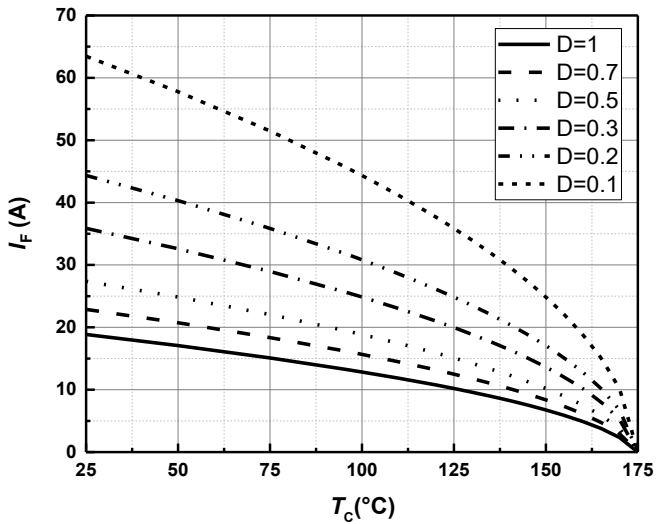
**Typical Performance**



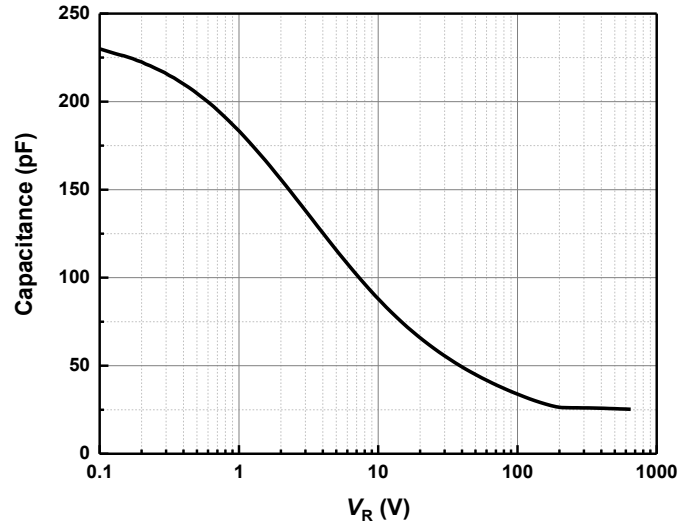
**Figure 1** Typical forward characteristics



**Figure 2** Typical reverse current as function of reverse voltage

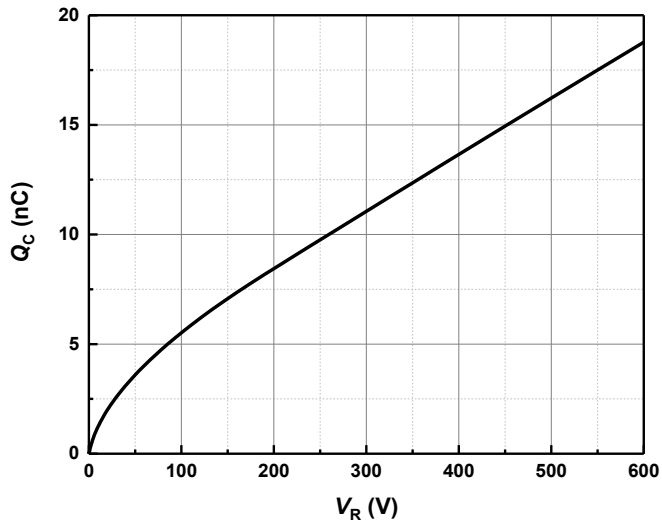


**Figure 3** Diode forward current as function of temperature, D=duty cycle

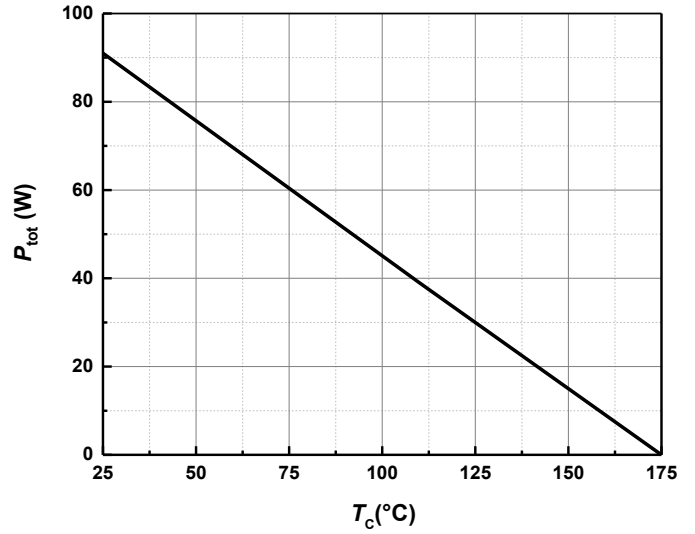


**Figure 4** Typical capacitance as function of reverse voltage,  $C=f(V_R)$ ;  $T_j=25^{\circ}$ C;  $f=1$  MHz

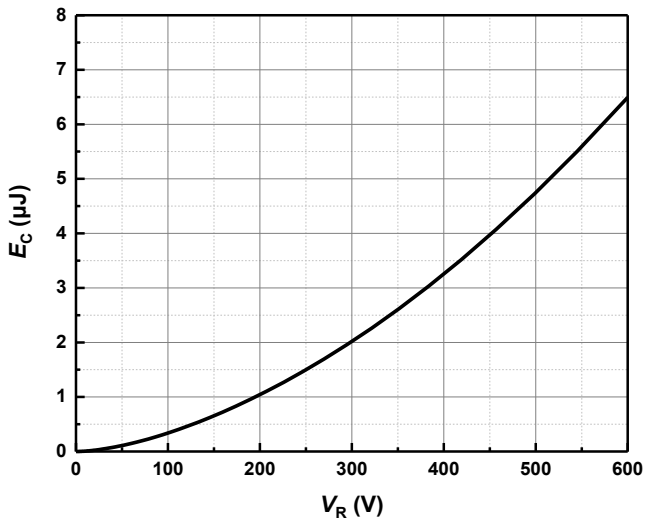
**Typical Performance**



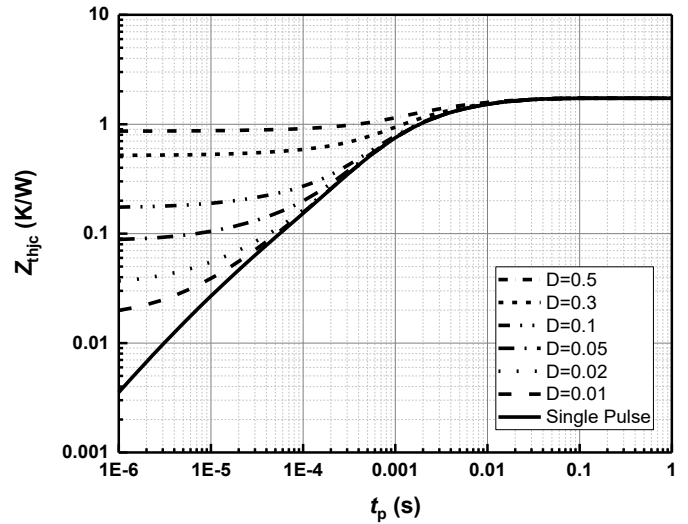
**Figure 5** Typical reverse charge as function of reverse voltage



**Figure 6** Power dissipation as function of case temperature

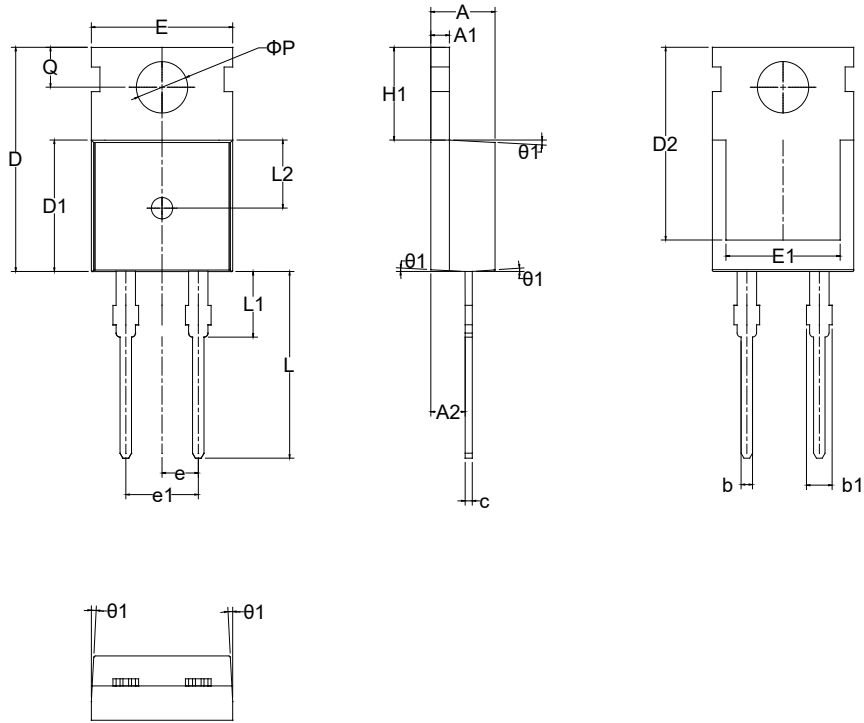


**Figure 7** Capacitance stored energy



**Figure 8** Max. transient thermal impedance,  $Z_{thjc} = f(t)$ , parameter:  $D = t / T$

**Package Dimensions**



SYMBOL	mm		
	MIN	NOM	MAX
A	4.40	4.50	4.60
A1	1.27	1.30	1.33
A2	2.30	2.40	2.50
b	0.70	-	0.90
b1	1.42	-	1.57
c	0.45	0.50	0.60
D	15.30	15.70	16.10
D1	9.10	9.20	9.30
D2	13.10	-	13.70
E	9.70	9.90	10.20
E1	7.80	8.00	8.20
e	2.54 BSC		
e1	5.08 BSC		
H1	6.30	6.50	6.70
L	12.78	13.08	13.38
L1	-	-	3.50
L2	4.60 REF		
$\phi P$	3.55	3.60	3.65
Q	2.73	-	2.87
$\theta 1$	1°	3°	5°

**Revision History**

<b>Document Version</b>	<b>Date of Release</b>	<b>Description of Changes</b>
Rev 0.0	2021-11-22	Release of the datasheet.

**BASiC Semiconductor Ltd.**  
**Shenzhen, China**  
**© 2021 BASiC Semiconductor Ltd.**  
**All Rights Reserved.**

**Information**

For further information on technology, delivery terms and conditions and prices, please contact the nearest BASiC Semiconductor Office

**Disclaimer**

The information given in this document shall in no event be regarded as a guarantee of conditions or characteristics. With respect to any examples or hints given herein, any typical values stated herein and/or any information regarding the application of the device, BASiC semiconductor Ltd. hereby disclaims any and all warranties and liabilities of any kind, including without limitation, warranties of non-infringement of intellectual property rights of any third party.